

*Energy Logic: Reducing Data Center Energy Consumption by
Creating Savings that Cascade Across Systems*

The model demonstrates that reductions in energy consumption at the IT equipment level have the greatest impact on overall consumption, because they cascade across all supporting systems.

Executive Summary

A number of associations, consultants and vendors have promoted best practices for enhancing data center energy efficiency. These practices cover everything from facility lighting to cooling system design, and have proven useful in helping some companies slow or reverse the trend of rising data center energy consumption. However, most organizations still lack a cohesive, holistic approach for reducing data center energy use.

Emerson Network Power analyzed the available energy-saving opportunities and identified the top 10. Each of these 10 opportunities were then applied to a 5,000-square-foot data center model based on real-world technologies and operating parameters. Through the model, Emerson Network Power was able to quantify the savings of each action at the system level, as well as identify how energy reduction in some systems affects consumption in supporting systems.

The model demonstrates that reductions in energy consumption at the IT equipment level have the greatest impact on overall consumption because they cascade across all supporting systems. This led to the development of Energy Logic, a vendor-neutral roadmap for optimizing data center energy efficiency that starts with the IT equipment and progresses to the support infrastructure. This paper shows how Energy Logic can deliver a 50 percent or greater reduction in data center energy consumption without compromising performance or availability.

This approach has the added benefit of removing the three most critical constraints faced by data center managers today: power, cooling and space. In the model, the 10 Energy Logic strategies freed up two-thirds of floor space, one-third of UPS capacity and 40 percent of precision cooling capacity.

All of the technologies used in the Energy Logic approach are available today and many can be phased into the data center as part of regular technology upgrades/refreshes, minimizing capital expenditures.

The model also identified some gaps in existing technologies that could enable greater energy reductions and help organizations make better decisions regarding the most efficient technologies for a particular data center.

Introduction

The double impact of rising data center energy consumption and rising energy costs has elevated the importance of data center efficiency as a strategy to reduce costs, manage capacity and promote environmental responsibility.

Data center energy consumption has been driven by the demand within almost every organization for greater computing capacity and increased IT centralization. While this was occurring, global electricity prices increased 56 percent between 2002 and 2006.

The financial implications are significant; estimates of annual power costs for U.S. data centers now range as high as \$3.3 billion.

This trend impacts data center capacity as well. According to the Fall 2007 Survey of the Data Center Users Group (DCUG®), an influential group of data center managers, power limitations were cited as the primary factor limiting growth by 46 percent of respondents, more than any other factor.

In addition to financial and capacity considerations, reducing data center energy use has become a priority for organizations seeking to reduce their environmental footprint.

There is general agreement that improvements in data center efficiency are possible. In a report to the U.S. Congress,

the Environmental Protection Agency concluded that best practices can reduce data center energy consumption by 50 percent by 2011.

The EPA report included a list of Top 10 Energy Saving Best Practices as identified by the Lawrence Berkeley National Lab. Other organizations, including Emerson Network Power, have distributed similar information, and there is evidence that some best practices are being adopted.

The Spring 2007 DCUG Survey found that 77 percent of respondents already had their data center arranged in a hot-aisle/ cold-aisle configuration to increase cooling system efficiency; 65 percent use blanking panels to minimize recirculation of hot air; and 56 percent have sealed the floor to prevent cooling losses.

While progress has been made, an objective, vendor-neutral evaluation of efficiency opportunities across the spectrum of data center systems has been lacking. This has made it difficult for data center managers to prioritize efficiency efforts and tailor best practices to their data center equipment and operating practices.

This paper closes that gap by outlining a holistic approach to energy reduction, based on quantitative analysis, which enables a 50 percent or greater reduction in data center energy consumption.

Data center energy consumption is being driven by the demand within almost every organization for greater computing capacity and increased IT centralization.

The distinction between demand and supply power consumption is valuable because reductions in demand-side energy use cascade through the supply side.

Data Center Energy Consumption

The first step in prioritizing energy saving opportunities was to gain a solid understanding of data center energy consumption.

Emerson Network Power modeled energy consumption for a typical 5,000-square-foot data center (Figure 1) and analyzed how energy is used within the facility. Energy use was categorized as either “demand side” or “supply side.”

Demand-side systems are the servers, storage, communications and other IT systems that support the business. Supply-side systems exist to support the demand side.

In this analysis, demand-side systems—which include processors, server power supplies, other server components, storage

and communication equipment—account for 52 percent of total consumption. Supply-side systems include the UPS, power distribution, cooling, lighting and building switchgear, and account for 48 percent of consumption.

Information on data center and infrastructure equipment and operating parameters on which the analysis was based are presented in Appendix A. Note that all data centers are different and the savings potential will vary by facility. However, at minimum, this analysis provides an order-of-magnitude comparison for data center energy reduction strategies.

The distinction between demand and supply power consumption is valuable because reductions in demand-side energy use cascade through the supply side. For example,

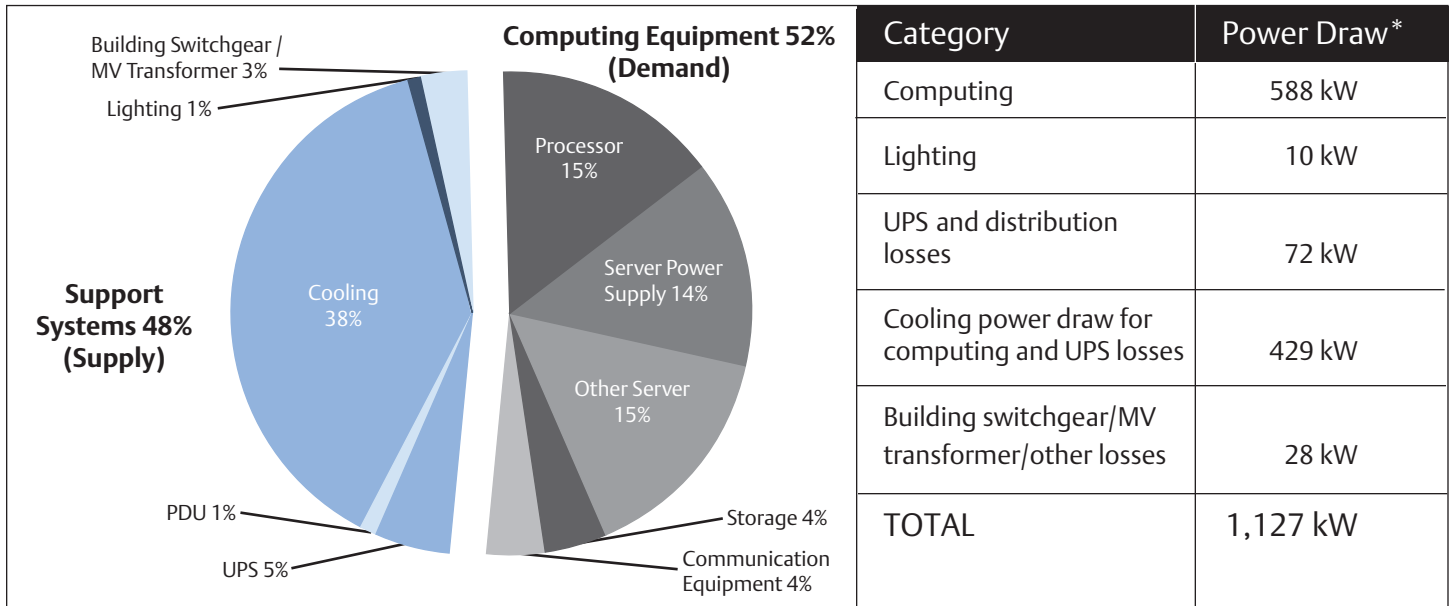

Figure 1. Analysis of a typical 5,000-square-foot data center shows that demand-side computing equipment accounts for 52 percent of energy usage and supply-side systems account for 48 percent.

* This represents the average power draw (kW). Daily energy consumption (kWh) can be captured by multiplying the power draw by 24.

in the 5,000-square-foot data center used to analyze energy consumption, a 1 Watt reduction at the server component level (processor, memory, hard disk, etc.) results in an additional 1.84-Watt savings in the power supply, power distribution system, UPS system, cooling system and building entrance switchgear and medium voltage transformer (Figure 2).

Consequently, every Watt of savings that can be achieved on the processor level creates approximately 2.84 Watts of savings for the facility.

The Energy Logic Approach

Energy Logic takes a sequential approach to reducing energy costs, applying the 10 technologies and best practices that exhibited the most potential in the order in which they have the greatest impact.

While the sequence is important, Energy Logic is not intended to be a step-by-step approach in the sense that each step can

only be undertaken after the previous one is complete. The energy-saving measures included in Energy Logic should be considered a guide. Many organizations will already have undertaken some measures at the end of the sequence or will have to deploy some technologies out of sequence to remove existing constraints to growth.

The first step in the Energy Logic approach is to establish an IT equipment procurement policy that exploits the energy efficiency benefits of low-power processors and high-efficiency power supplies.

As these technologies are specified in new equipment, inefficient servers will be phased out and replaced with higher-efficiency units, creating a solid foundation for an energy-optimized data center.

Power management software has great potential to reduce energy costs and should be considered as part of an energy optimization strategy, particularly for data centers that have large differences between peak

The first step in the Energy Logic approach is to establish an IT equipment procurement policy that exploits the energy efficiency benefits of low-power processors and high-efficiency power supplies.

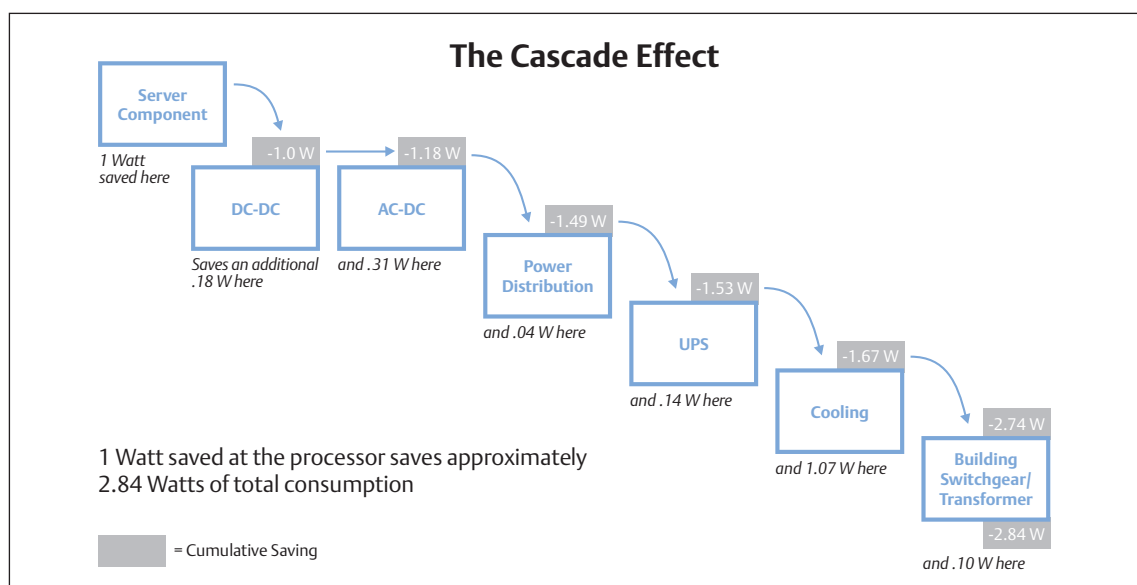

Figure 2. With the Cascade Effect, a 1-Watt savings at the server-component level creates a reduction in facility energy consumption of approximately 2.84 Watts.

Total floor space required for IT equipment was reduced by 65 percent.

and average utilization rates. Other facilities may choose not to employ power management because of concerns about response times. A significant opportunity exists within the industry to enhance the sophistication of power management to make it an even more powerful tool in managing energy use.

The next step involves IT projects that may not be driven by efficiency considerations, but have an impact on energy consumption. They include:

- Blade servers
- Server virtualization

These technologies have emerged as “best practice” approaches to data center management and play a role in optimizing a data center for efficiency, performance and manageability.

Once policies and plans have been put in place to optimize IT systems, the focus shifts to supply-side systems. The most effective approaches to infrastructure optimization include:

- Cooling best practices
- Higher voltage AC power distribution
- Variable-capacity cooling
- Supplemental cooling
- Monitoring and optimization

Emerson Network Power has quantified the savings that can be achieved through each of these actions individually and as part of the Energy Logic sequence (Figure 3). Note that savings for supply-side systems look smaller when taken as part of Energy Logic because those systems are now supporting a smaller load.

Reducing Energy Consumption and Eliminating Constraints to Growth

Employing the Energy Logic approach to the model data center reduced energy use by 52 percent without compromising performance or availability.

In its unoptimized state, the 5,000-square-foot data center model used to develop the Energy Logic approach supported a total compute load of 588 kW and total facility load of 1,127 kW. Through the optimization strategies presented here, this facility has been transformed to enable the same level of performance using significantly less power and space. Total compute load was reduced to 367 kW, while rack density was increased from 2.8 kW per rack to 6.1 kW per rack.

This has reduced the number of racks required to support the compute load from 210 to 60 and eliminated power, cooling and space limitations constraining growth (Figure 4).

Total energy consumption was reduced to 542 kW and the total floor space required for IT equipment was reduced by 65 percent (Figure 5).

Energy Logic is suitable for every type of data center; however, the sequence may be affected by facility type. Facilities operating at high-utilization rates throughout a 24-hour day will want to focus initial efforts on sourcing IT equipment with low-power processors and high-efficiency power supplies. Facilities that experience predictable peaks in activity may achieve the greatest benefit from power management technology. Figure 6 shows how compute load and type of operation influence priorities.

Energy-Saving Action	Savings Independent of Other Actions		Energy Logic Savings with the Cascade Effect			ROI
	Savings (kW)	Savings (%)	Savings (kW)	Savings (%)	Cumulative Savings (kW)	
Low-power processors	111	10%	111	10%	111	12 to 18 mo.
High-efficiency power supplies	141	12%	124	11%	235	5 to 7 mo.
Power management features	125	11%	86	8%	321	Immediate
Blade servers	8	1%	7	1%	328	TCO reduced 38%*
Server virtualization	156	14%	86	8%	414	TCO reduced 63%**
Higher voltage AC power distribution***	34	3%	20	2%	434	2 to 3 mo.
Cooling best practices	24	2%	15	1%	449	4 to 6 mo.
Variable-capacity cooling: variable speed fan drives	79	7%	49	4%	498	4 to 10 mo.
Supplemental cooling	200	18%	72	6%	570	10 to 12 mo.
Monitoring and optimization: Cooling units work as a team	25	2%	15	1%	585	3 to 6 mo.

* Source for blade impact on TCO: IDC ** Source for virtualization impact on TCO: VMware

*** Adjusted to reflect additional insight gained when applying this strategy.

Figure 3. Using the model of a 5,000-square-foot data center consuming 1,127 kW of power, the actions included in the Energy Logic approach work together to produce a 585 kW reduction in energy use.

Constraint	Unoptimized	Optimized	Capacity Freed Up
Data center space (sq ft)	4,988	1,768	3,220 (65%)
UPS capacity (kVA)	2 * 750	2 * 500	2 * 250 (33%)
Cooling plant capacity (tons)	350	200	150 (43%)
Building entrance switchgear and genset (kW)	1,169	620	549 (47%)

Figure 4. Energy Logic removes constraints to growth in addition to reducing energy consumption.

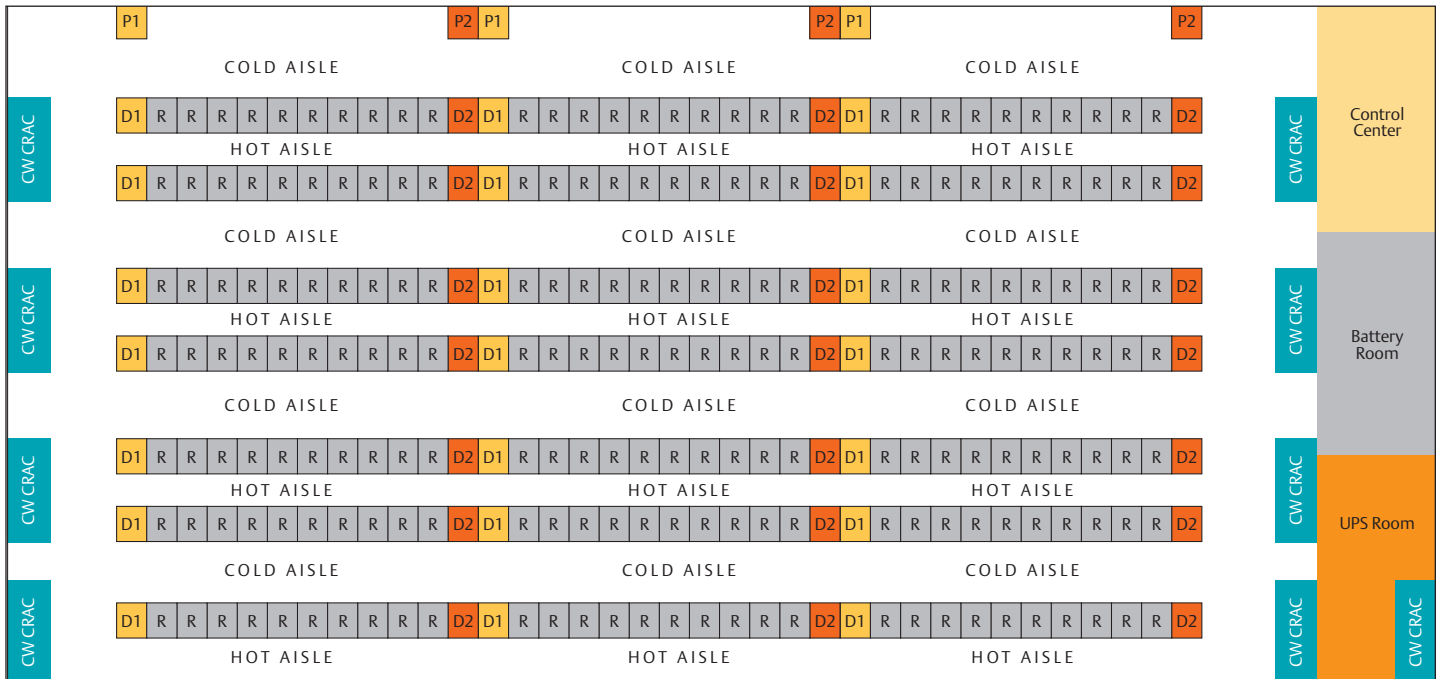

Before Energy Logic

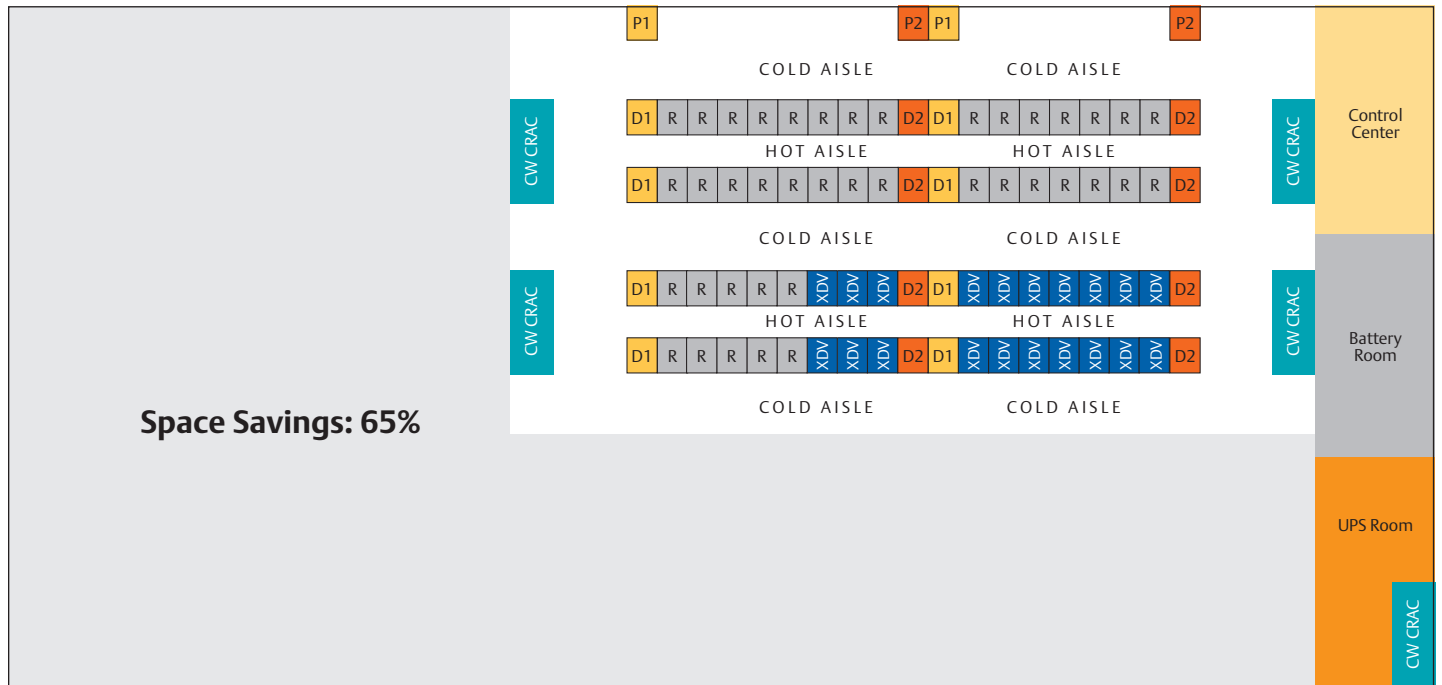

After Energy Logic

P1 = Stage one distribution, side A D1 = Stage two distribution, side A R = Rack
P2 = Stage one distribution, side B D2 = Stage two distribution, side B XDV = Supplemental-cooling module
CW CRAC = Chilled-water computer room air conditioner

Figure 5. The top diagram shows the unoptimized data center layout. The lower diagram shows the data center after the Energy Logic actions were applied. Space required to support data center equipment was reduced from 5,000 square feet to 1,768 square feet (65 percent).

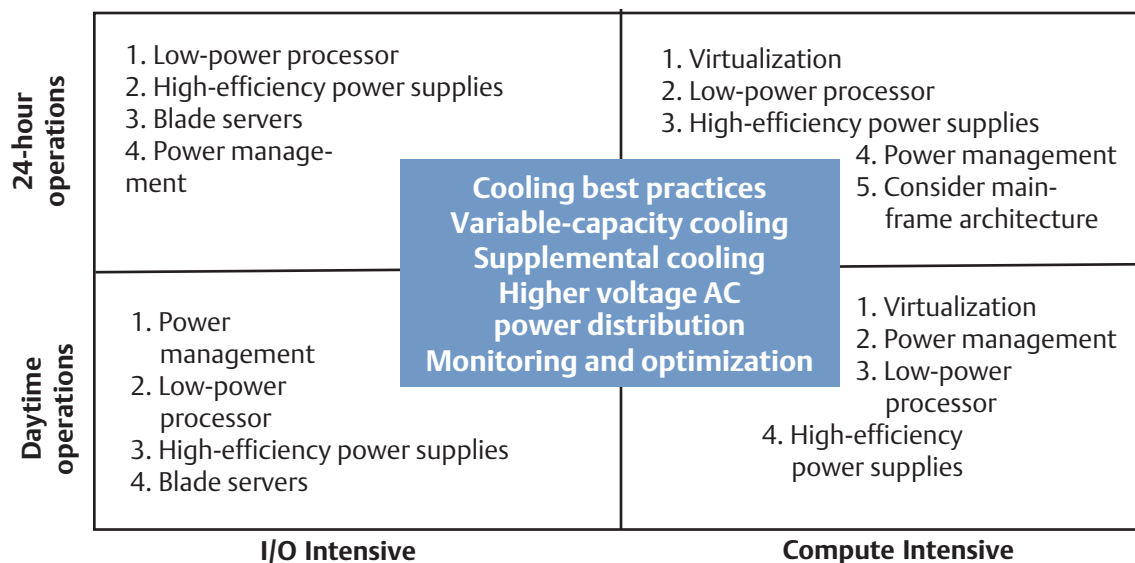

Figure 6 . The Energy Logic approach can be tailored to the compute load and type of operation.

The Ten Energy Logic Actions

1. Processor Efficiency

In the absence of a true standard measure of processor efficiency comparable to the U.S. Department of Transportation fuel efficiency standard for automobiles, Thermal Design Power (TDP) serves as a proxy for server power consumption.

The typical TDP of processors in use today is between 80 and 103 Watts (91 W average). For a price premium, processor manufacturers provide lower voltage versions of their processors that consume on average 30 Watts less than standard processors (Figure 7). Independent research studies show these low-power processors

deliver the same performance as higher power models (Figure 8).

In the 5,000-square-foot data center modeled for this paper, low-power processors create a 10 percent reduction in overall data center power consumption.

2. Power Supplies

As with processors, many of the server power supplies in use today are operating at efficiencies below what is currently available. The U.S. EPA estimated the average efficiency of installed server power supplies at 72 percent in 2005. In the model, we assume the unoptimized data center uses power supplies that average 79 percent across a mix of servers that range from four years old to new.

	Sockets	Speed (GHz)	Standard	Low power	Saving
AMD	1	1.8-2.6	103 W	65 W	38 W
	2	1.8-2.6	95 W	68 W	27 W
Intel	2	1.8-2.6	80 W	50 W	30 W

Figure 7. Intel and AMD offer a variety of low-power processors that deliver average savings between 27 W and 38 W.

System Performance Results

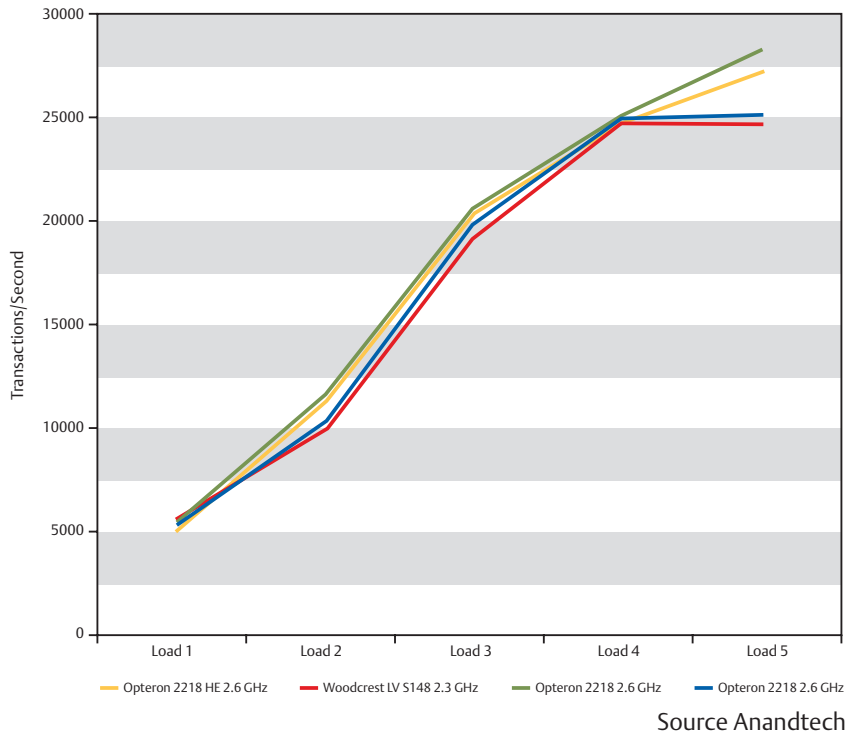

Figure 8. Performance results for standard- and low-power processor systems using the American National Standard Institute AS3AP benchmark.

Best-in-class power supplies are available today that deliver efficiency of 90 percent. Use of these power supplies reduces power draw within the data center by 124 kW or 11 percent of the 1,127 kW total.

As with other data center systems, server power supply efficiency varies depending on load. Some power supplies perform better at partial loads than others and this is particularly important in dual-corded devices where power supply utilization can average less than 30 percent. Figure 9 shows power supply efficiencies at different loads for two power supply models. At 20 percent load, model A has an efficiency of approximately 88 percent while model B has an efficiency closer to 82 percent.

Figure 9 also highlights another opportunity to increase efficiency: sizing power supplies closer to actual load. Notice that the maximum configuration is about 80 percent of

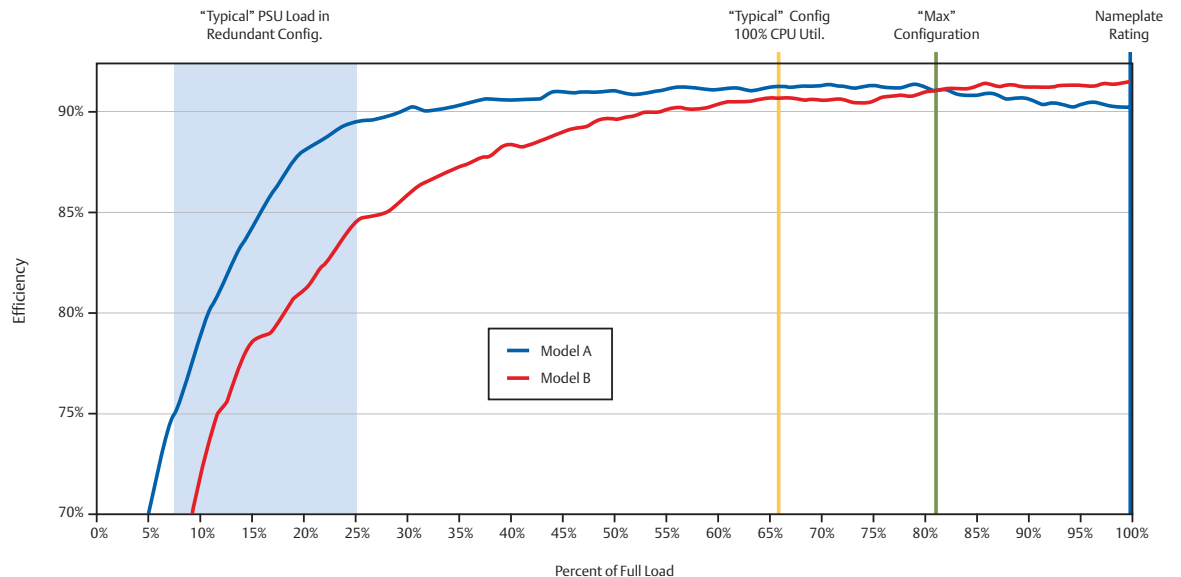

Figure 9. Power supply efficiency can vary significantly depending on load, and power supplies are often sized for a load that exceeds the maximum server configuration.

the nameplate rating and the typical configuration is 67 percent of the nameplate rating. Server manufacturers should allow purchasers to choose power supplies sized for a typical or maximum configuration.

3. Power management software

Data centers are sized for peak conditions that may rarely exist. In a typical business data center, daily demand progressively increases from about 5 a.m. to 11 a.m. and then begins to drop again at 5 p.m. (Figure 10).

Server power consumption remains relatively high as server load decreases (Figure 11). In idle mode, most servers consume between 70 and 85 percent of full operational power. Consequently, a facility operating at just 20 percent capacity may use 80 percent of the energy as the same facility operating at 100 percent capacity.

Server processors have power management features built-in that can reduce power when the processor is idle. Too often these features

are disabled because of concerns regarding response time; however, this decision may need to be re-evaluated in light of the significant savings this technology can enable.

In the model, we assume that the idle power draw is 80 percent of the peak power draw without power management, and reduces to 45 percent of peak power draw as power management is enabled. With this scenario, power management can save an additional 86 kW or 8 percent of the unoptimized data center load.

4. Blade Servers

Many organizations have implemented blade servers to meet processing requirements and improve server management. While the move to blade servers is typically not driven by energy considerations, blade servers can play a role in energy consumption.

Blade servers consume about 10 percent less power than equivalent rack mount servers, because multiple servers share common

While the move to blade servers is typically not driven by energy considerations, blade servers can play a role in reducing energy consumption.

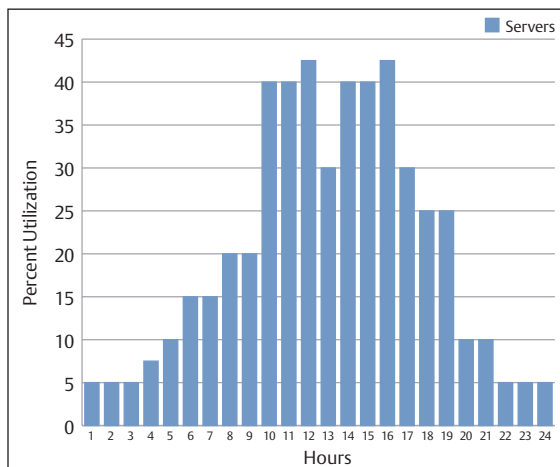

Figure 10. Daily utilization for a typical business data center.

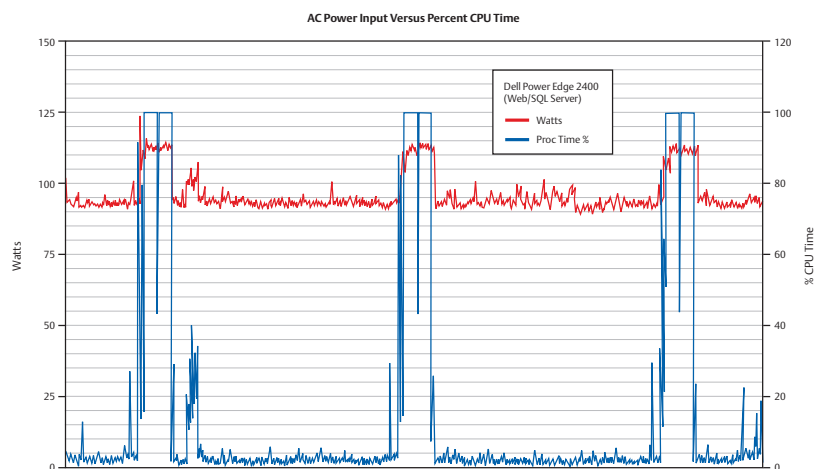

Figure 11. Low processor activity does not translate into low power consumption.

Implementing virtualization provides an incremental 8 percent reduction in total data center power draw for the 5,000-square-foot facility.

power supplies, cooling fans and other components.

In the model, we see a 1 percent reduction in total energy consumption when 20 percent of rack-based servers are replaced with blade servers. More importantly, blades facilitate the move to a high-density data center architecture, which can significantly reduce energy consumption.

5. Server Virtualization

As server technologies are optimized, virtualization is increasingly being deployed to increase server utilization and reduce the number of servers required.

In our model, we assume that 25 percent of servers are virtualized with eight non-virtualized physical servers being replaced by one virtualized physical server. We also assume that the applications being virtualized were residing in single-processor and two-processor servers and the virtualized applications are hosted on servers with at least two processors.

Implementing virtualization provides an incremental 8 percent reduction in total data center power draw for the 5,000-square-foot facility.

6. Higher Voltage AC Power Distribution

The critical power system represents another opportunity to reduce energy consumption; however, even more than other systems, care must be taken to ensure reductions in energy consumption are not achieved at the cost of reduced equipment availability.

Most data centers use a type of UPS called a double-conversion system. These systems convert incoming power to DC and then back

to AC within the UPS. This enables the UPS to generate a clean, consistent waveform for IT equipment and effectively isolates IT equipment from the power source.

UPS systems that don't convert the incoming power—line interactive or passive standby systems—can operate at higher efficiencies because of the losses associated with the conversion process. These systems may compromise equipment protection, because they do not fully condition incoming power.

A bigger opportunity exists downstream from the UPS. In most data centers, the UPS delivers power to the server at 208V. If the voltage can be raised to 240V, the power supplies in the servers will operate at increased efficiency. Servers and other IT equipment can handle 240V AC inputs without other issues.

Depending on the way the power distribution is architected to deliver this higher AC voltage, energy savings can be as high as 2 percent of the total energy consumption with the cascade effect and up to 3 percent taken on its own.

7. Cooling Best Practices

Most data centers have implemented some best practices, such as the hot-aisle/cold-aisle rack arrangement. Potential exists in sealing gaps in floors, using blanking panels in open spaces in racks, and avoiding mixing of hot and cold air. ASHRAE has published several excellent papers on these best practices.

Computational fluid dynamics (CFD) can be used to identify inefficiencies and optimize data center airflow (Figure 12). Many organizations, including Emerson Network

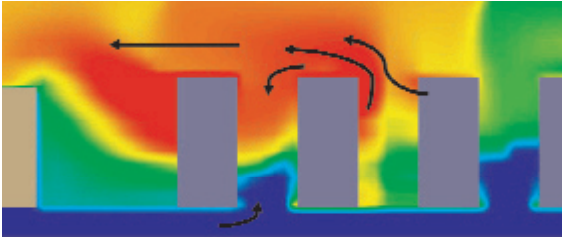

Figure 12. CFD imaging can be used to evaluate cooling efficiency and optimize airflow. This image shows hot air being recirculated as it is pulled back toward the CRAC, which is poorly positioned.

Power, offer CFD imaging as part of data center assessment services focused on improving cooling efficiency.

Additionally, temperatures in the cold aisle may be able to be raised if current temperatures are below 68° F. Chilled water temperatures can often be raised from 45° F to 50° F.

In the model, cooling system efficiency is improved 5percent simply by implementing best practices. This reduces overall facility energy costs by 1 percent with virtually no investment in new technology.

8. Variable-Capacity Cooling

Data center systems are sized to handle peak loads, which rarely exist. Consequently, operating efficiency at full load is often not a good indication of actual operating efficiency.

Newer technologies, such as Digital Scroll compressors and variable frequency drives in computer room air conditioners (CRACs), allow high efficiencies to be maintained at partial loads.

Digital scroll compressors allow the capacity of room air conditioners to be matched exactly to room conditions without turning compressors on and off.

Typically, CRAC fans run at a constant speed and deliver a constant volume of air flow. Converting these fans to variable frequency drive fans allows fan speed and power draw to be reduced as load decreases. Fan power is directly proportional to the cube of fan rpm and a 20 percent reduction in fan speed provides almost 50 percent savings in fan power consumption. These drives are available in retrofit kits that make it easy to upgrade existing CRACs with a payback of less than one year.

Newer technologies such as Digital Scroll compressors and variable frequency drives in computer room air conditioners (CRACs) allow high efficiencies to be maintained at partial loads.

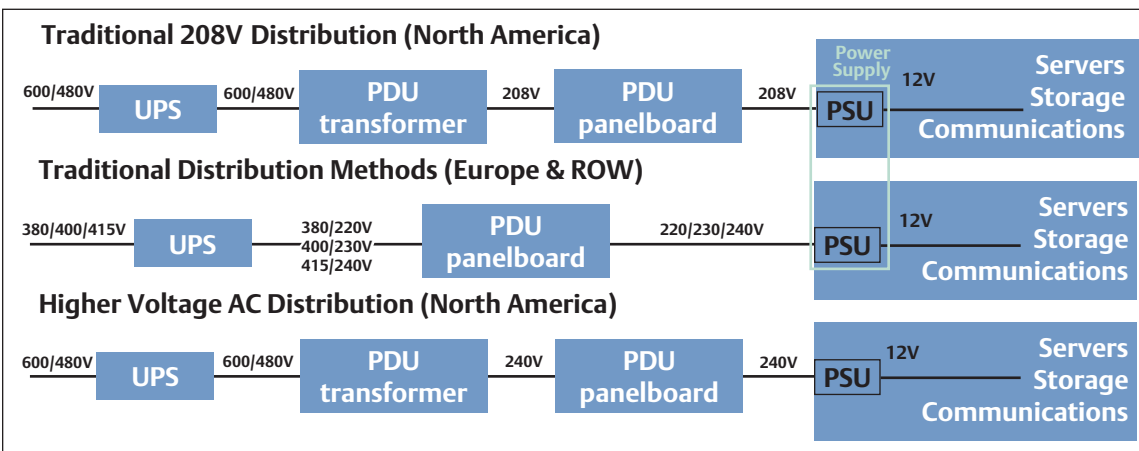

Figure 13. Higher Voltage AC power distribution provides a more efficient alternative to using 208V power.

Supplemental cooling units are mounted above or alongside equipment racks and pull hot air directly from the hot aisle and deliver cold air to the cold aisle.

In the chilled water-based air conditioning system used in this analysis, the use of variable frequency drives provides an incremental saving of 4 percent in data center power consumption.

9. High-Density Supplemental Cooling

Traditional room-cooling systems have proven very effective at maintaining a safe, controlled environment for IT equipment. However, optimizing data center energy efficiency requires moving from traditional data center densities (2 to 3 kW per rack) to an environment that can support much higher densities (in excess of 30 kW).

This requires implementing an approach to cooling that shifts some of the cooling load from traditional CRAC units to supplemental cooling units. Supplemental cooling units are mounted above or alongside equipment racks (Figure 14), and pull hot air directly from the hot aisle and deliver cold air to the cold aisle.

Supplemental cooling units can reduce cooling costs by 30 percent compared to traditional approaches to cooling. These savings are achieved because supplemental cooling brings cooling closer to the source of heat, reducing the fan power required to move air. They also use more efficient heat exchangers and deliver only sensible cooling, which is ideal for the dry heat generated by electronic equipment.

Refrigerant is delivered to the supplemental cooling modules through an overhead piping system, which, once installed, allows cooling modules to be easily added or relocated as the environment changes.



Figure 14. Supplemental cooling enables higher rack densities and improved cooling efficiency.

In the model, 20 racks at 12 kW density per rack use high-density supplemental cooling while the remaining 40 racks (at 3.2 kW density) are supported by the traditional room cooling system. This creates an incremental 6 percent reduction in overall data center energy costs. As the facility evolves and more racks move to high density, the savings will increase.

10. Monitoring and Optimization

One of the consequences of rising equipment densities has been increased diversity within the data center. Rack densities are rarely uniform across a facility and this can create cooling inefficiencies if monitoring and optimization is not implemented. Room cooling units on one side of a facility may be humidifying the environment based on local conditions while units on the opposite side of the facility are dehumidifying.

Cooling control systems can monitor conditions across the data center and coordinate the activities of multiple units to prevent conflicts and increase teamwork (Figure 15).

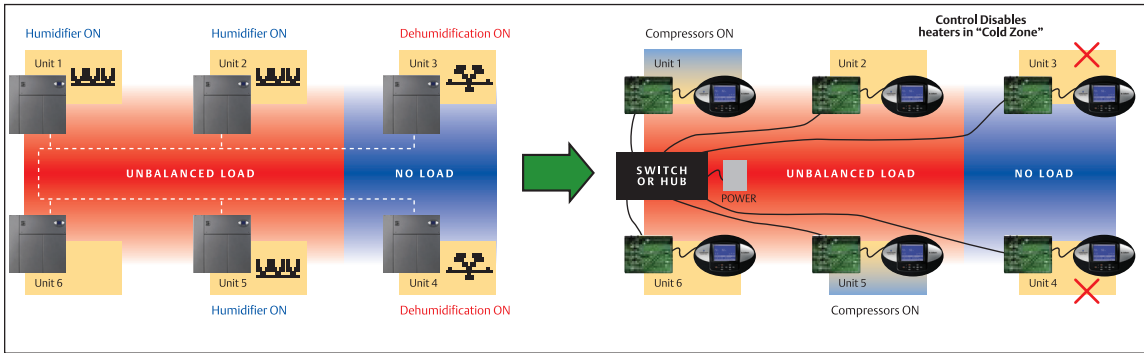

Figure 15. System-level control reduces conflict between room air conditioning units operating in different zones in the data center.

In the model, an incremental savings of 1 percent is achieved as a result of system-level monitoring and control.

Other Opportunities for Savings

Energy Logic prioritizes the most effective energy reduction strategies, but it is not intended to be a comprehensive list of energy-reducing measures. In addition to the actions in the Energy Logic strategy, data center managers should consider the feasibility of the following:

- Consolidate data storage from direct attached storage to network attached storage. Also, faster disks consume more power so consider reorganizing data so that less frequently used data is on slower archival drives.
- Use economizers where appropriate to allow outside air to be used to support data center cooling during colder months, creating opportunities for energy-free cooling. With today's high-density computing environment, economizers can be cost-effective in many more locations than might be expected.

- Monitor and reduce parasitic losses from generators, exterior lighting and perimeter access control. For a 1 MW load, generator losses of 20 kW to 50 kW have been measured.

What the Industry Can Learn from the Energy Logic Model

The Energy Logic model not only prioritizes actions for data center managers, it also provides a roadmap for the industry to deliver the information and technologies that data center managers can use to optimize their facilities. Here are specific actions the industry can take to support increased data center efficiency:

1. Define universally accepted metrics for processor, server and data center efficiency

There have been tremendous technology advances in server processors in the last decade. Until 2005, higher processor performance was linked with higher clock speeds and hotter chips consuming more power. Recent advances in multi-core technology have driven performance increases by using more computing cores operating at relatively lesser clock speeds, which reduces power consumption.

The Energy Logic model also provides a roadmap for the industry to deliver the information and technologies that data center managers can use to optimize their facilities.

An industry standard of data center efficiency that measures performance per Watt of energy used would be extremely beneficial in measuring the progress of data center optimization efforts.

Today processor manufacturers offer a range of server processors from which a customer needs to select the right processor for the given application. What is lacking is an easy-to-understand and easy-to-use measure, such as the miles-per-gallon automotive fuel efficiency ratings developed by the U.S. Department of Transportation, that can help buyers select the ideal processor for a given load. The performance-per-Watt metric is evolving gradually with SPEC score being used as the server performance measure, but more work is needed.

This same philosophy could be applied to the facility level. An industry standard of data center efficiency that measures performance per Watt of energy used would be extremely beneficial in measuring the progress of data center optimization efforts. The PUE ratio developed by the Green Grid provides a measure of infrastructure efficiency, but not total facility efficiency. IT management needs to work with IT equipment and infrastructure manufacturers to develop the miles-per-gallon equivalent for both systems and facilities.

2. More sophisticated power management

While enabling power management features provides tremendous savings, IT management often prefers to stay away from this technology as the impact on availability is not clearly established. As more tools become available to manage power management features, and data is available to ensure that availability is not impacted, we should see this technology gain market acceptance. More sophisticated controls that would allow these features to be enabled only during periods of low utilization, or turned off when critical applications are being processed, would elimi-

nate much of the resistance to using power management.

3. Matching power supply capacity to server configuration

Server manufacturers tend to oversize power supplies to accommodate the maximum configuration of a particular server. Some users may be willing to pay an efficiency penalty for the flexibility to more easily upgrade, but many would prefer a choice between a power supply sized for a standard configuration and one sized for maximum configuration. Server manufacturers should consider making these options available and users need to be educated about the impact power supply size has on energy consumption.

4. Designing for high density

A perception persists that high-density environments are more expensive than simply spreading the load over a larger space. High-density environments employing blade and virtualized servers are actually economical, as they drive down energy costs and remove constraints to growth, often delaying or eliminating the need to build new facilities.

5. Higher voltage distribution

Using higher AC voltages for power distribution reduces losses. In Europe and Asia, higher AC voltages of 415V are common in most countries. U.S. manufacturers of UPS systems should provide higher voltage AC output options beyond 208V AC, and should educate customers on the benefits of higher voltage power distribution.

6. Integrated measurement and control

Data that can be easily collected from IT systems and the racks that support them has

yet to be effectively integrated with support system controls. This level of integration would allow IT systems, applications and support systems to be more effectively managed based on actual conditions at the IT equipment level.

Conclusion

Data center managers and designers, IT equipment manufacturers and infrastructure providers must all collaborate to truly optimize data center efficiency.

For data center managers, there are a number of actions that can be taken today that can significantly drive down energy consumption while freeing physical space and power and cooling capacity to support growth.

Energy-reduction initiatives should begin with policies that encourage the use of efficient IT technologies, specifically low-power processors and high-efficiency power supplies. This will allow more efficient technologies to be introduced into the data center as part of the normal equipment replacement cycle.

Power management software should also be considered in applications where it is appropriate as it may provide greater savings than any other single technology, depending on data center utilization.

IT consolidation projects also play an important role in data center optimization. Both blade servers and virtualization contribute to energy savings and support a high-density environment that facilitates true optimization.

The final steps in the Energy Logic optimization strategy is to focus on infrastructure systems, employing a combination of best practices and efficient technologies to increase the efficiency of power and cooling systems.

Together these strategies created a 52 percent reduction in energy use in the 5,000-square-foot data center model developed by Emerson Network Power while removing constraints to growth.

Appendix B shows exactly how these savings are achieved over time as legacy technologies are phased out and savings cascade across systems.

Together these strategies created a 52 percent reduction in energy use in the 5,000-square-foot data center model developed by Emerson Network Power while removing constraints to growth.

Appendix A: Data Center Assumptions Used to Model Energy Use

To quantify the results of the efficiency improvement options presented in this paper, a hypothetical data center that has not been optimized for energy efficiency was created. The 10 efficiency actions presented in this paper were then applied to this facility sequentially to quantify results.

This 5,000-square-foot hypothetical data center has 210 racks with average heat density of 2.8kW/rack. The racks are arranged in a hot-aisle/cold-aisle configuration. Cold aisles are four feet wide, and hot aisles are three feet wide. Based on this configuration and operating parameters, average facility power draw was calculated to be 1,127 kW. Following are additional details used in the analysis.

Servers

- Age is based on average server replacement cycle of 4-5 years.
- Processor Thermal Design Power averages 91W/processor.
- All servers have dual-redundant power supplies. The average DC-DC conversion efficiency is assumed at 85% and average AC-DC conversion efficiency is assumed at 79 percent for the mix of servers from four-years old to new.
- Daytime power draw is assumed to exist for 14 hours on weekdays and 4 hours on weekends. Night time power draw is 80 percent of daytime power draw.
- See Figure 16 for more details on server configuration and operating parameters.

	Single Socket	Two Sockets	Four Sockets	More than Four	Total
Number of servers	157	812	84	11	1,064
Daytime power draw (Watts/server)	277	446	893	4,387	–
Nighttime power draw (Watts/server)	247	388	775	3,605	–
Total daytime power draw (kW)	44	362	75	47	528
Total nighttime power draw (kW)	39	315	65	38	457
Average server power draw (kW)	41	337	70	42	490

Figure 16. Server operating parameters used in the Energy Logic model.

Storage

- Storage Type: Network attached storage.
- Capacity is 120 Terabytes.
- Average Power Draw is 49 kW.

Communication Equipment

- Routers, switches and hubs required to interconnect the servers, storage and access points through Local Area Network and provide secure access to public networks.
- Average Power Draw is 49 kW.

Power Distribution Units (PDU):

- Provide output of 208V, 3 Phase through whips and rack power strips to power servers, storage, communication equipment and lighting. (Average load is 539 kW).
- Input from UPS is 480V 3 phase.
- Efficiency of power distribution is 97.5 percent.

UPS System

- Two double-conversion 750 kVA UPS modules arranged in dual-redundant (1 +1) configuration with input filters for power factor correction (power factor = 91 percent).
- The UPS receives 480V input power for the distribution board and provides 480V, 3-Phase power to the power distribution units on the data center floor.
- UPS efficiency at part load: 91.5 percent.

Cooling system

- Cooling System is chilled-water based.
- Total sensible heat load on the precision cooling system includes heat generated by the IT equipment, UPS and PDUs, building egress and human load.
- Cooling System Components:
 - Eight 128.5 kW chilled-water based precision cooling units placed at the end of each hot aisle. Includes one redundant unit.
 - The chilled water source is a chiller plant consisting of three 200-ton chillers (n+1) with matching condensers for heat rejection and four chilled water pumps (n+2).
 - The chiller, pumps and air conditioners are powered from the building distribution board (480V 3 phase).
 - Total cooling system power draw is 429 kW.

Building substation:

- The building substation provides 480V 3-phase power to UPS's and cooling system.
- Average load on building substation is 1,099 kW.
- Utility input is 13.5 kVA, 3-phase connection.
- System consists of transformer with isolation switchgear on the incoming line, switchgear, circuit breakers and distribution panel on the low-voltage line.
- Substation, transformer and building entrance switchgear composite efficiency is 97.5 percent.

Appendix B: Timing Benefits from Efficiency Improvement Actions

Efficiency Improvement Area		Savings (kW)	Estimated Cumulative Yearly Savings				
			Year 1	Year 2	Year 3	Year 4	Year 5
IT Policies	Low-power processors	111	6	22	45	78	111
	High-efficiency power supplies	124	12	43	68	99	124
	Server power management	86	9	26	43	65	86
IT Projects	Blade servers	7	1	7	7	7	7
	Virtualization	86	9	65	69	86	86
Best Practices	Higher voltage AC power distribution	20	0	0	20	20	20
	Cooling best practices	15	15	15	15	15	15
	Variable-capacity cooling	49	49	49	49	49	49
Infrastructure Projects	High-density supplemental cooling	72	0	57	72	72	72
	Monitoring and optimization	15	0	15	15	15	15
		585	100	299	402	505	585

Note: Energy Logic is an approach developed by Emerson Network Power to provide organizations with the information they need to more effectively reduce data center energy consumption. It is not directly tied to a particular Emerson Network Power product or service. We encourage use of the Energy Logic approach in industry discussions on energy efficiency and will permit use of the Energy Logic graphics with the following attribution:

The Energy Logic approach developed by Emerson Network Power.

To request a graphic send an email to energylogic@emersonnetworkpower.com.

Emerson Network Power

1050 Dearborn Drive
P.O. Box 29186
Columbus, Ohio 43229
800.877.9222 (U.S. & Canada Only)
614.888.0246 (Outside U.S.)
Fax: 614.841.6022

EmersonNetworkPower.com
Liebert.com

While every precaution has been taken to ensure accuracy and completeness in this literature, Liebert Corporation assumes no responsibility, and disclaims all liability for damages resulting from use of this information or for any errors or omissions. Specifications subject to change without notice. © 2008 Liebert Corporation. All rights reserved throughout the world. Trademarks or registered trademarks are property of their respective owners. ® Liebert and the Liebert logo are registered trademarks of the Liebert Corporation Business-Critical Continuity, Emerson Network Power and the Emerson Network Power logo are trademarks and service mark of the Emerson Electric Co.

SL-24621(0809)

Emerson Network Power.

The global leader in enabling *Business-Critical Continuity™*.

- AC Power
- Embedded Computing
- Connectivity
- Embedded Power
- DC Power
- Infrastructure Management & Monitoring

- Outside Plant
- Power Switching & Controls
- Precision Cooling

EmersonNetworkPower.com

- Racks & Integrated Cabinets
- Services
- Surge Protection